



MOULDER & PCD TOOLS



WHEN PERFORMANCE COUNTS

MICOR
TOOLING



CONTENTS

DIAMOND TOOLS	8
CNC TOOLS	14
CUTTER WITH REVERSIBLE & PROFILE KNIVES	20
PLANING CUTTER HEAD	26
PANELLING & FLOORING CUTTER SET	34
STRAIGHT CUTTERS	42
PROFILE CUTTERS	46
PROFILE CUTTERS FOR LOGHOUSE	56
PLANER SPLITTING	59
INSULATION CUTTERS	60
HOGGER UNITS	61



WHEN PERFORM COUNTS

COUNT ON US

Micor Tooling offers a complete portfolio of saw blades, band saw blades, planing tools, moulders and PCD tools. At our three manufacturing sites in Sweden, and Finland we produce our world leading brands; Micor, Langshyttan, BBM and LTT which are sold to over 40 countries worldwide. Building on our more than 150 years of combined know-how, we know what is required. Given that Micor Tooling has multiple production sites we can maintain short lead times and flexibility when service counts.

Micor Tooling's aim is to develop highly efficient tools, create innovative ideas and to set sustainable trends. These innovations not only make production processes faster, more flexible, and more cost-effective, but also combine ecology and economy with the best machining quality.

At Micor Tooling, craftsmanship and personal commitment, combined with ongoing efforts to improve and develop ourselves, provides us with a consistent high level of quality. Micor Tooling use renewable energy and is ISO 9001/14001-certified.

PERFORMANCE

OUR PRODUCTION SITES DELIVERS THE SOLUTIONS OF TOMORROW

Our modernly equipt production sites are driven by developing and producing the world's most effective and innovative cutting tools within our different segments. We are proud to deliver the products and solutions of tomorrow.

LÅNGSHYTTAN, SWEDEN

For almost 150 years our site in Långshyttan has offered a grinding service and manufactured band saw blades for the sawmill industry. The knowledge of the plant cant be seen anywhere else in the world. The plant is situated in the deep forest of Dalarna in Sweden.

LAHOLM, SWEDEN

The production plant in Laholm focus on the production and development of our segments circular saw blades and planing tools. With modern equipment in newly renovated facilities, we daily develop solutions on tomorrows products and needs. You access the site easy in Laholm, we are situated close to E6 and south of Halmstad in Sweden.

LAHTI, FINLAND

Driven by the mission of developing and producing the world's best planing tools in moulding and PVC. Over 60 years have made LTT a leading profiled tool manufacturer in Finland. Lahden Teräteos Oy is located in Lahti, southern Finland, only 100 km from Helsinki.





micor
CIRCULAR SAW BLADES

The Micor circular saw blades has been around since the mid-50's and was one of the pioneers in the industry and in developing the technology to furnish saw blades with hard metal inserts. Today, Micor manufactures saw blades for industrial use, where high demands are placed on precision, performance, and endurance. The Micor saw blades are commonly encountered and supplied to different industries, such as: Wood, Metal, Plastic and Food processing industries. The circular saw blades are manufactured in the south of Sweden.



LANGSHYTTAN
BAND SAW BLADES

The Langshyttan band saw blades has been synonymous with high Swedish quality for more than 50 years and is recognised worldwide as a professional partner with outstanding products and service. Over the years, Langshyttan has constantly developed its product offer and today it manufactures a wide variety of band saw blades for all different kind of need at the highest quality. Given the location and expertise, Langshyttan drives the band saw blade innovation for the most challenging cutting conditions.



BBM
PLANING TOOLS

The BBM opened its doors 1987 and are one of the very few players in that market that still exist today and is considered to manufacture very high-quality product that are sold around the world and are constant commitment to offer premium products that gives longer running times and swift deliveries. What makes the BBM products so admired. The Swedish craftsmanship has proven a great success over the years, as quality assurance is in the DNA, and this is synonymous to the BBM brand.



LTT LAHDEN TERÄTEOS
MOULDER & PCD TOOLS

In Finland, Lahden Teräteos is a manufacturing pioneer of, among others, diamond blades, developed for woodworking applications and requiring demanding specially qualified know-how since 1960. Continuous further development of products and services, together with highly trained and motivated personnel has made LTT as a leading profiled tool manufacturer in Finland. LTT are able to offer the highest grinding quality for PCD diamond tools and offering the best sharpening service.

WHEN PERFORMANCE COUNTS. YOU CAN COUNT ON OUR PRODUCTS.

We develop world leading products that meet the highest customer demands, building on our more than 150 years of combined know-how. We know what is required when performance counts and you will find our cutting tools all over the world.



STRAIGHT SHANK-TYPE CUTTERS



POWERFUL AND ECONOMIC SOLUTION

- Up-down design, clean cut both up and bottom.
- Resharpenable 2-3 times.
- Excellent stability.
- Up to 5 mm tip height, re-sharpenable several times.



TECHNICAL DATA

STRAIGHT SHANK-TYPE CUTTER Z=1+1

ORDER-NO	SHANK D	CUTTING D	TOTAL WIDTH	CUTTING WIDTH
TIYKE10	12	12	85	25
TIYKE20	16	16	85	25
TIYKE21	16	16	100	35
TIYKE30	25	18	96	35
TIYKE31	20	18	109	43
TIYKE40	25	20	86	25
TIYKE41	25	20	100	35

STRAIGHT SHANK-TYPE CUTTER Z=3+3

ORDER-NO	SHANK D	CUTTING D	TOTAL WIDTH	CUTTING WIDTH
TIYKE103	12	12	85	25
TIYKE203	16	16	85	25
TIYKE213	16	16	100	35
TIYKE303	25	18	96	35
TIYKE313	20	18	109	43
TIYKE403	25	20	86	25
TIYKE413	25	20	100	35





JOINT CUTTERS



LTT JOINTING CUTTERS

- Up to 5 mm tip height, re-sharpenable several times.
- Excellent chip-free jointing.
- Optimized chip removal.
- Silent cut.
- Customazation upon request.



TECHNICAL DATA

STANDARD DIMENSIONS

ORDER-NO	DIAMETER MM	CUTTING WHIDTH	BODY WIDTH	BORE	Z
0	100	48	25	30	2+2
0	100	63	25	30	2+2
0	125	34	38	30	3+3
0	125	43	40	30	3+3
0	125	63	40	30	3+3

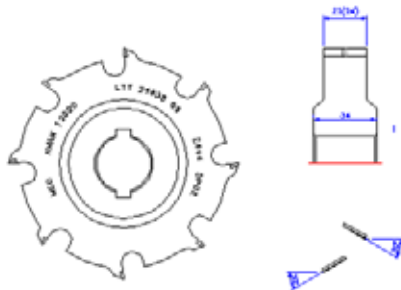



PROFILED SHANK-TYPE CUTTERS



- The tools are designed based on the profiles and forms requested by the customer.
- Quick delivery.
- Up to 5 mm tip height, re-sharpenable several times.



TECHNICAL DATA

ORDER-NO	CUTTING DIAM	Z	CUTTING WIDTH MM
TIY402002	42	2	20
TIY503002	53	2	33
TIY401002	38	2	843



PROFILED CUTTERS

- The tools are designed based on the profiles and forms requested by the customer.
- Quick delivery.
- Up to 5 mm tip height, re-sharpenable several times.





DIAMOND SAW BLADES



TECHNICAL DATA

DP CIRCULAR SAW BLADE

ORDER-NO	D	Z	LENGTH	TIP HIGHT
TIP2404855	240	48	3,4	5,5
TIP2506055	250	60	3,2	5,5
TIP3006055	300	60	4,4	5,5
TIP3007255	300	72	3,2	5,5
TIP3505460	350	54	4,0	6
TIP3507255	350	72	4,0	5,5
TIP3507260	350	72	4,0	6
TIP4007245	400	72	4,5	4,5

DP CIRCULAR SCORING SAW BLADE

ORDER-NO	D	Z	LENGTH	TIP HIGHT
TIP1272460	127	24	4/5	6
TIP1602055	160	20	4,4/5,2	5,5
TIP1603055	160	30	4,5/5,5	5,5
TIP3004845	300	48	4,4/4,5	4,5



HOGGERS

LONG EDGE LIFE, EXCELLENT CUTTING QUALITY

- For double hogging with edge trimming machines and det's.
- Clean cutting result.
- High hogging volume.
- For coated and raw particle board, recycling boards, etc.
- Hogging width and clamping according customer.



TECHNICAL DATA

EXAMPLE HOGGERS DP

ORDER-NO	DIAMETER	BORE	HOGGING WIDTH	Z
TIM250301010	250	60	10	30/10
TIM250301018	250	60	18	30/10



PROFILED SHANK-TYPE CUTTER



PROFILE GROUPS 1

D	LEIK.LENGHT	ORDER NO
20	10	CN02010M1
20	15	CN02015M1
20	20	CN02020M1
20	25	CN02025M1
20	30	CN02030M1
20	35	CN02035M1
20	40	CN02040M1
20	45	CN02045M1
20	50	CN02050M1

D	LEIK.LENGHT	ORDER NO
50	10	CN05010M1
50	15	CN05015M1
50	20	CN05020M1
50	25	CN05025M1
50	30	CN05030M1
50	35	CN05035M1
50	40	CN05040M1
50	45	CN05045M1
50	50	CN05050M1

D	LEIK.LENGHT	ORDER NO
100	10	CN010010M1
100	15	CN010015M1
100	20	CN010020M1
100	25	CN010025M1
100	30	CN010030M1
100	35	CN010035M1
100	40	CN010040M1
100	45	CN010045M1
100	50	CN010050M1

D	LEIK.LENGHT	ORDER NO
30	10	CN03010M1
30	15	CN03015M1
30	20	CN03020M1
30	25	CN03025M1
30	30	CN03030M1
30	35	CN03035M1
30	40	CN03040M1
30	45	CN03045M1
30	50	CN03050M1

D	LEIK.LENGHT	ORDER NO
60	10	CN06010M1
60	15	CN06015M1
60	20	CN06020M1
60	25	CN06025M1
60	30	CN06030M1
60	35	CN06035M1
60	40	CN06040M1
60	45	CN06045M1
60	50	CN06050M1

D	LEIK.LENGHT	ORDER NO
120	10	CN012010M1
120	15	CN012015M1
120	20	CN012020M1
120	25	CN012025M1
120	30	CN012030M1
120	35	CN012035M1
120	40	CN012040M1
120	45	CN012045M1
120	50	CN012050M1

D	LEIK.LENGHT	ORDER NO
40	10	CN04010M1
40	15	CN04015M1
40	20	CN04020M1
40	25	CN04025M1
40	30	CN04030M1
40	35	CN04035M1
40	40	CN04040M1
40	45	CN04045M1
40	50	CN04050M1

D	LEIK.LENGHT	ORDER NO
80	10	CN08010M1
80	15	CN08015M1
80	20	CN08020M1
80	25	CN08025M1
80	30	CN08030M1
80	35	CN08035M1
80	40	CN08040M1
80	45	CN08045M1
80	50	CN08050M1

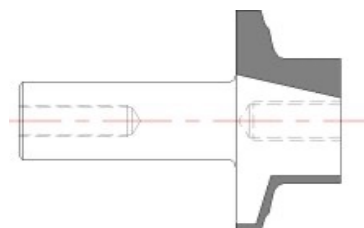

IF YOU CAN'T FIND WHAT YOU'RE LOOKING FOR PLEASE CONTACT: SUPPORT@MICORTOOLING.COM



PROFILED SHANK-TYPE CUTTER



PROFILE GROUPS 2

D	LEIK.LENGHT	ORDER NO
20	10	CN02010M2
20	15	CN02015M2
20	20	CN02020M2
20	25	CN02025M2
20	30	CN02030M2
20	35	CN02035M2
20	40	CN02040M2
20	45	CN02045M2
20	50	CN02050M2

D	LEIK.LENGHT	ORDER NO
50	10	CN05010M2
50	15	CN05015M2
50	20	CN05020M2
50	25	CN05025M2
50	30	CN05030M2
50	35	CN05035M2
50	40	CN05040M2
50	45	CN05045M2
50	50	CN05050M2

D	LEIK.LENGHT	ORDER NO
100	10	CN10010M2
100	15	CN10015M2
100	20	CN10020M2
100	25	CN10025M2
100	30	CN10030M2
100	35	CN10035M2
100	40	CN10040M2
100	45	CN10045M2
100	50	CN10050M2

D	LEIK.LENGHT	ORDER NO
30	10	CN03010M2
30	15	CN03015M2
30	20	CN03020M2
30	25	CN03025M2
30	30	CN03030M2
30	35	CN03035M2
30	40	CN03040M2
30	45	CN03045M2
30	50	CN03050M2

D	LEIK.LENGHT	ORDER NO
60	10	CN06010M2
60	15	CN06015M2
60	20	CN06020M2
60	25	CN06025M2
60	30	CN06030M2
60	35	CN06035M2
60	40	CN06040M2
60	45	CN06045M2
60	50	CN06050M2

D	LEIK.LENGHT	ORDER NO
120	10	CN12010M2
120	15	CN12015M2
120	20	CN12020M2
120	25	CN12025M2
120	30	CN12030M2
120	35	CN12035M2
120	40	CN12040M2
120	45	CN12045M2
120	50	CN12050M2

D	LEIK.LENGHT	ORDER NO
40	10	CN04010M2
40	15	CN04015M2
40	20	CN04020M2
40	25	CN04025M2
40	30	CN04030M2
40	35	CN04035M2
40	40	CN04040M2
40	45	CN04045M2
40	50	CN04050M2

D	LEIK.LENGHT	ORDER NO
80	10	CN08010M2
80	15	CN08015M2
80	20	CN08020M2
80	25	CN08025M2
80	30	CN08030M2
80	35	CN08035M2
80	40	CN08040M2
80	45	CN08045M2
80	50	CN08050M2

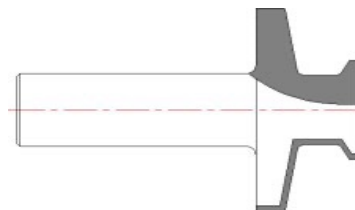



PROFILED SHANK-TYPE CUTTER

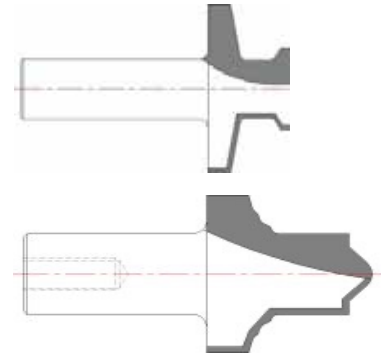

PROFILE GROUPS 3

D	LEIK.LENGHT	ORDER NO
20	10	CN02010M3
20	15	CN02015M3
20	20	CN02020M3
20	25	CN02025M3
20	30	CN02030M3
20	35	CN02035M3
20	40	CN02040M3
20	45	CN02045M3
20	50	CN02050M3

D	LEIK.LENGHT	ORDER NO
50	10	CN05010M3
50	15	CN05015M3
50	20	CN05020M3
50	25	CN05025M3
50	30	CN05030M3
50	35	CN05035M3
50	40	CN05040M3
50	45	CN05045M3
50	50	CN05050M3

D	LEIK.LENGHT	ORDER NO
100	10	CN010010M3
100	15	CN010015M3
100	20	CN010020M3
100	25	CN010025M3
100	30	CN010030M3
100	35	CN010035M3
100	40	CN010040M3
100	45	CN010045M3
100	50	CN010050M3

D	LEIK.LENGHT	ORDER NO
30	10	CN03010M3
30	15	CN03015M3
30	20	CN03020M3
30	25	CN03025M3
30	30	CN03030M3
30	35	CN03035M3
30	40	CN03040M3
30	45	CN03045M3
30	50	CN03050M3

D	LEIK.LENGHT	ORDER NO
60	10	CN06010M3
60	15	CN06015M3
60	20	CN06020M3
60	25	CN06025M3
60	30	CN06030M3
60	35	CN06035M3
60	40	CN06040M3
60	45	CN06045M3
60	50	CN06050M3

D	LEIK.LENGHT	ORDER NO
120	10	CN012010M3
120	15	CN012015M3
120	20	CN012020M3
120	25	CN012025M3
120	30	CN012030M3
120	35	CN012035M3
120	40	CN012040M3
120	45	CN012045M3
120	50	CN012050M3

D	LEIK.LENGHT	ORDER NO
40	10	CN04010M3
40	15	CN04015M3
40	20	CN04020M3
40	25	CN04025M3
40	30	CN04030M3
40	35	CN04035M3
40	40	CN04040M3
40	45	CN04045M3
40	50	CN04050M3

D	LEIK.LENGHT	ORDER NO
80	10	CN08010M3
80	15	CN08015M3
80	20	CN08020M3
80	25	CN08025M3
80	30	CN08030M3
80	35	CN08035M3
80	40	CN08040M3
80	45	CN08045M3
80	50	CN08050M3

IF YOU CAN'T FIND WHAT YOU'RE LOOKING FOR PLEASE CONTACT: SUPPORT@MICORTOOLING.COM



DOWEL DRILL



- From standard tools to loghouse.



D	L2	L1	S	Z	ORDER NO
4	30	57,5	10x20	2	PT0430575
5	30	57,5	10x20	2	PT0530575
6	30	57,5	10x20	2	PT0630575
7	30	57,5	10x20	2	PT0730575
8	30	57,5	10x20	2	PT0830575
9	30	57,5	10x20	2	PT0930575
10	30	57,5	10x20	2	PT01030575
11	30	57,5	10x20	2	PT01130575
12	30	57,5	10x20	2	PT01230575
14	30	57,5	10x20	2	PT01430575
15	30	57,5	10x20	2	PT01530575
16	30	57,5	10x20	2	PT01630575

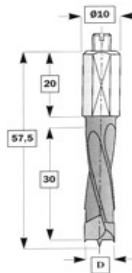

D	L2	L1	S	Z	ORDER NO
4	43	70	10x20	2	PT044370
5	43	70	10x20	2	PT054370
6	43	70	10x20	2	PT064370
7	43	70	10x20	2	PT074370
8	43	70	10x20	2	PT074370
9	43	70	10x20	2	PT084370
10	43	70	10x20	2	PT0104370
11	43	70	10x20	2	PT0114370
12	43	70	10x20	2	PT0124370
14	43	70	10x20	2	PT0144370
15	43	70	10x20	2	PT0154370
16	43	70	10x20	2	PT0164370

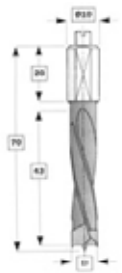

D	L2	L1	S	Z	ORDER NO
5	50	85	10x30	2	PT055085
6	50	85	10x30	2	PT065085
8	50	85	10x30	2	PT085085
10	50	85	10x30	2	PT0105085
12	50	85	10x30	2	PT0125085

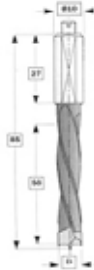



CYLINDER BORING BITS

- From standard tools to loghouse.

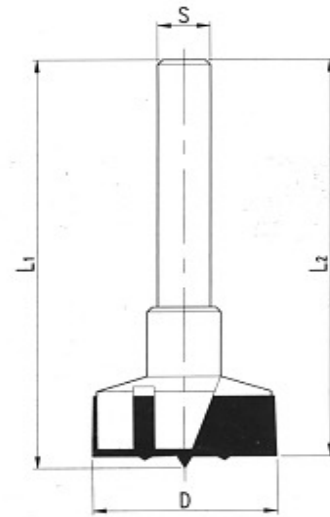

TECHNICAL DATA

D	L2	L1	S	Z	ORDER NO
15	60	90	10x30	2+2	OP0156090
16	60	90	10x30	2+2	OP0169090
18	60	90	10x30	2+2	OP0186090
20	60	90	10x30	2+2	OP0206090
22	60	90	10x30	2+2	OP0226090
23	60	90	10x30	2+2	OP0236090
24	60	90	10x30	2+2	OP0246090
25	60	90	10x30	2+2	OP0256090
26	60	90	10x30	2+2	OP0266090
28	60	90	10x30	2+2	OP0286090
30	60	90	10x30	2+2	OP0306090
32	60	90	10x30	2+2	OP0326090
35	60	90	10x30	2+2	OP0356090
38	60	90	10x30	2+2	OP0386090
40	60	90	10x30	2+2	OP0406090
45	60	90	10x30	2+2	OP0456090
50	60	90	10x30	2+2	OP0506090



STRAIGHT SHANK TYPE CUTTER

- Customized dimensions upon request.

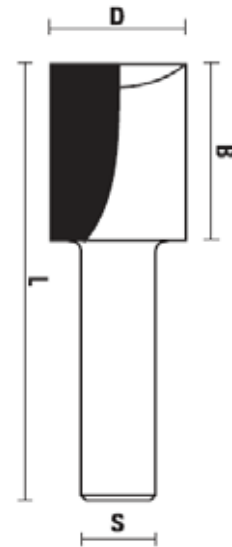

TECHNICAL DATA

D	L2	L1	S	Z	ORDER NO
8	20	60	10x35	2	SJ082060
10	25	70	10x35	2	SJ0102570
12	25	70	10x35	2	SJ0122570
14	25	70	10x35	2	SJ0142570
16	25	70	10x35	2	SJ0162570
18	25	70	10x35	2	SJ0182570
20	25	70	10x35	2	SJ0202570
22	25	70	10x35	2	SJ0222570
25	25	70	10x35	2	SJ0252570
30	25	70	10x35	2	SJ0302570
10	40	90	12x45	2	SJ0104090
12	40	90	12x45	2	SJ0124090
14	40	90	12x45	2	SJ0144090
16	40	90	12x45	2	SJ0164090
18	40	90	12x45	2	SJ0184090
20	40	90	12x45	2	SJ0204090
22	40	90	12x45	2	SJ0224090
24	40	90	12x45	2	SJ0244090

CUTTER WITH REVERSIBLE AND PROFILE KNIVES



UNIVERSAL PROFILE MILLING HEAD



- Profile according to the customers needs.
- Quick delivery.



TECHNICAL DATA

ORDER-NO	D	B	Z	BORE	INSERT KNIVES	PD MAX
LTT01.001	124	40	2/3/4	30	40x28x1,5	12,0
LTT01.002	134	40	2/3/4	40	40x28x1,5	12,0
LTT01.003	144	40	2/3/4	50	40x28x1,5	12,0
LTT01.004	152	40	2/3/4	60	40x28x1,5	12,5

ORDER-NO	D	B	Z	BORE	INSERT KNIVES	PD MAX
LTT01.005	136	40	2/3/4	30	40x35x1,5	18,0
LTT01.006	134	40	2/3/4	40	40x35x1,5	18,0
LTT01.007	144	40	2/3/4	50	40x35x1,5	18,0
LTT01.008	152	40	2/3/4	60	40x35x1,5	18,5

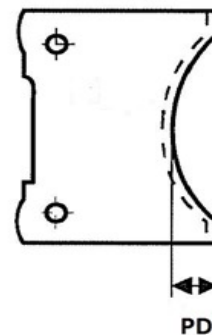

n-mx.9000



SHANK CUTTER FOR CNC ROUTER



- Profile according to the customers needs.
- Quick delivery.



TECHNICAL DATA

ORDER-NO	D	B	Z	BORE	INSERT KNIVES	PD MAX
LTT01.001	124	40	2/3/4	30	40x28x1,5	12,0
LTT01.002	134	40	2/3/4	40	40x28x1,5	12,0
LTT01.003	144	40	2/3/4	50	40x28x1,5	12,0
LTT01.004	152	40	2/3/4	60	40x28x1,5	12,5

ORDER-NO	D	B	Z	BORE	INSERT KNIVES	PD MAX
LTT01.005	136	40	2/3/4	30	40x35x1,5	18,0
LTT01.006	134	40	2/3/4	40	40x35x1,5	18,0
LTT01.007	144	40	2/3/4	50	40x35x1,5	18,0
LTT01.008	152	40	2/3/4	60	40x35x1,5	18,5

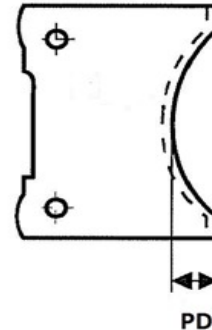

n-mx.12000



SHANK CUTTERS WITH CHANGEABLE KNIVES



CUTTERS WITH CHANGEABLE KNIVES





PROFILE KNIVES

- Profile according to the customers needs.
- Quick delivery.



TECHNICAL DATA

ORDER-NO	D	H	S
MP412820	41	28	2,0
MP413520	41	35	2,0
MP514520	51	45	2,0
MP614520	61	45	2,0
MP814520	81	45	2,0



TURNOVER KNIVES



- Standard knives, customized upon request.
- Quick delivery.



TECHNICAL DATA

TURNOVER KNIFE 35° T04F,
FOR MDF HDF

ORDER-NO	D	H	S
VP0512	12	12	1,5
VP0515	15	12	1,5
VP0520	20	12	1,5
VP0525	25	12	1,5
VP0530	30	12	1,5
VP0540	40	12	1,5
VP0550	50	12	1,5
VP0560	60	12	1,5
VP05195	19,5	12	1,5
VP05295	29,5	12	1,5
VP05395	39,5	12	1,5
VP05495	49,5	12	1,5
VP05595	59,5	12	1,5
VP0514	14	14	2

TURNOVER KNIFE 35° T10MG,
FOR SOFT AND HARD WOOD

ORDER-NO	D	H	S
VP0512	12	12	1,5
VP0515	15	12	1,5
VP0520	20	12	1,5
VP0525	25	12	1,5
VP0530	30	12	1,5
VP0540	40	12	1,5
VP0550	50	12	1,5
VP0560	60	12	1,5
VP05195	19,5	12	1,5
VP05295	29,5	12	1,5
VP05395	39,5	12	1,5
VP05495	49,5	12	1,5
VP05595	59,5	12	1,5
VP0514	14	14	2

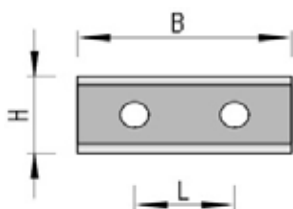



PLANING CUTTER HEAD



PLANING CUTTER HEAD



- Product manufactured based on customer dimension needs.
- Maximum diameter 360 mm and length 600 mm.
- Quick delivery times.
- Available in aluminum and steel.



TECHNICAL DATA

LENGHT	D100 Z2	D100 Z4	D120 Z2	D120 Z4
50	GA110005002	GA110005004	GA112005002	GA112005004
80	GA110008002	GA110008004	GA112008002	GA112008004
100	GA110010002	GA110010004	GA112010002	GA112010004
125	GA110012502	GA110012504	GA112012502	GA112012504
150	GA110015002	GA110015004	GA112015002	GA112015004
180	GA110018002	GA110018004	GA112018002	GA112018004
200	GA110020002	GA110020004	GA112020002	GA112020004
250	GA110025002	GA110025004	GA112025002	GA112025004

LENGHT	D180 Z4	D180 Z6	D180 Z8
50	GA118005004	GA118005006	GA118005008
80	GA118008004	GA118008006	GA118008008
100	GA118010004	GA118010006	GA118010008
125	GA118012504	GA118012506	GA118012508
150	GA118015004	GA118015006	GA118015008
180	GA118018004	GA118018006	GA118018008
200	GA118020004	GA118020006	GA118020008
250	GA118025004	GA118025006	GA118025008

LENGHT	D140 Z4	D140 Z6	D160 Z4	D160 Z6
50	GA114005004	GA114005006	GA116005004	GA116005006
80	GA114008004	GA114008006	GA116008004	GA116008006
100	GA114010004	GA114010006	GA116010004	GA116010006
125	GA114012504	GA114012506	GA116012504	GA116012506
150	GA114015004	GA114015006	GA116015004	GA116015006
180	GA114018004	GA114018006	GA116018004	GA116018006
200	GA114020004	GA114020006	GA116020004	GA116020006
250	GA114025004	GA114025006	GA116025004	GA116025006

IF YOU CAN'T FIND WHAT YOU'RE LOOKING FOR PLEASE CONTACT: SUPPORT@MICORTOOLING.COM



PLANING CUTTER HEAD



- Product manufactured based on customer dimension needs.
- Maximum diameter 360 mm and length 600 mm.
- Quick delivery times.
- Available in aluminum and steel.



TECHNICAL DATA

LENGHT	D200 Z4	D200 Z6	D200 Z8	D200 Z10
50	GA120005004	GA120005006	GA120005008	GA120005010
80	GA120008004	GA120008006	GA120008008	GA120008010
100	GA120010004	GA120010006	GA120010008	GA120010010
125	GA120012504	GA120012506	GA120012508	GA120012510
150	GA120015004	GA120015006	GA120015008	GA120015010
180	GA120018004	GA120018006	GA120018008	GA120018010
200	GA120020004	GA120020006	GA120020008	GA120020010
250	GA120025004	GA120025006	GA120025008	GA120025010

LENGHT	D250 Z8	D250 Z10	D250 Z12
50	GA125005008	GA125005010	GA125005012
80	GA125008008	GA125008010	GA125008012
100	GA125010008	GA125010010	GA125010012
125	GA125012508	GA125012510	GA125012512
150	GA125015008	GA125015010	GA125015012
180	GA125018008	GA125018010	GA125018012
200	GA125020008	GA125020010	GA125020012
250	GA125025008	GA125025010	GA125025012

LENGHT	D220 Z6	D220 Z8	D220 Z10	D220 Z12
50	GA122005006	GA122005008	GA122005010	GA122005012
80	GA122008006	GA122008008	GA122008010	GA122008012
100	GA122010006	GA122010008	GA122010010	GA122010012
125	GA122012506	GA122012508	GA122012510	GA122012512
150	GA122015006	GA122015008	GA122015010	GA122015012
180	GA122018006	GA122018008	GA122018010	GA122018012
200	GA122020006	GA122020008	GA122020010	GA122020012
250	GA122025006	GA122025008	GA122025010	GA122025012

LENGHT	D250 Z16	D250 Z18	D300 Z20	D350 Z22
200	GA125020016	GA125020018	GA130020020	GA135020022
250	GA125025016	GA125025018	GA130025020	GA135025022
300	GA125030016	GA125030018	GA130030020	GA135030022
400	GA125040016	GA125040018	GA130040020	GA135040022

IF YOU CAN'T FIND WHAT YOU'RE LOOKING FOR PLEASE CONTACT: SUPPORT@MICORTOOLING.COM



HYDRO PLANING CUTTER HEAD



- Product manufactured based on customer dimension needs.
- Maximum diameter 360 mm and length 600 mm.
- Quick delivery times.
- Available in aluminum and steel.
- Up to Z=20.



TECHNICAL DATA

LENGHT	D160 Z4	D160 Z6	D180 Z6	D180 Z8
125	GB116012504	GB116012506	GB118012506	GB118012508
150	GB116015004	GB116015006	GB118015006	GB118015008
180	GB116018004	GB116018006	GB118018006	GB118018008
200	GB116020004	GB116020006	GB118020006	GB118020008
250	GB116025004	GB116025006	GB118025006	GB118025008

LENGHT	D220 Z8	D220 Z10	D220 Z12	D250 Z8
125	GB122012508	GB122012510	GB122012512	GB125012508
150	GB122015008	GB122015010	GB122015012	GB125015008
180	GB122018008	GB122018010	GB122018012	GB125018008
200	GB122020008	GB122020010	GB122020012	GB125020008
250	GB122025008	GB122025010	GB122025012	GB125025008

LENGHT	D200 Z6	D200 Z8	D200 Z10
125	GB120012506	GB120012508	GB120012510
150	GB120015006	GB120015008	GB120015010
180	GB120018006	GB120018008	GB120018010
200	GB120020006	GB120020008	GB120020010
250	GB120025006	GB120025008	GB120025010

LENGHT	D250 Z10	D250 Z12	D230 Z16	D250 Z16
125	GB125012510	GB125012512	-	-
150	GB125015010	GB125015012	GB123015016	GB125015016
180	GB125018010	GB125018012	GB123018016	GB125018016
200	GB125020010	GB125020012	GB123020016	GB125020016
250	GB125025010	GB125025012	GB123025016	GB125025016

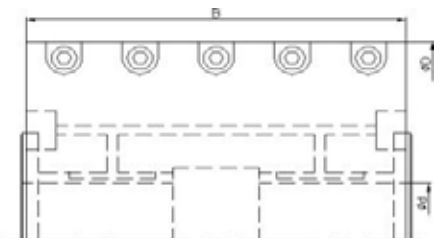

LENGHT	D250 Z18	D300 Z20	D350 Z22
200	GB125020018	GB130020020	GB135020022
250	GB125025018	GB130025020	GB135025022
300	GB125030018	GB130030020	GB135030022
400	GB125040018	GB130040020	GB135040022

IF YOU CAN'T FIND WHAT YOU'RE LOOKING FOR PLEASE CONTACT: SUPPORT@MICORTOOLING.COM



KNIVES FOR PLANER HEAD

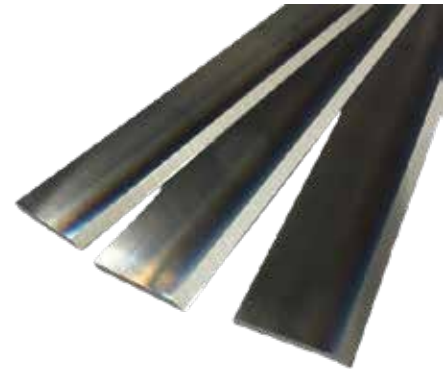

TECHNICAL DATA

LENGHT	LENGHT 3*30 MM	LENGHT 3*35 MM
80	PINGR03080	PINGR03580
90	PINGR03090	PINGR03590
100	PINGR030100	PINGR035100
120	PINGR030120	PINGR035120
140	PINGR030140	PINGR035140
160	PINGR030160	PINGR035160
180	PINGR030180	PINGR035180
200	PINGR030200	PINGR035200
220	PINGR030220	PINGR035220
240	PINGR030240	PINGR035240
260	PINGR030260	PINGR035260

LENGHT	LENGHT 3*30 MM	LENGHT 3*35 MM
80	GP53080	GP53580
100	GP530100	GP535100
120	GP530120	GP535120
140	GP530140	GP535140
160	GP530160	GP535160
180	GP530180	GP535180
200	GP530200	GP535200
220	GP530220	GP535220
240	GP530240	GP535240
260	GP530260	GP535260
280	GP530280	GP535280
300	GP530300	GP535300
1050	GP5301050	GP5351050

LENGHT	LENGHT 3*30 MM	LENGHT 3*35 MM
80	GR03080	GR03580
90	GR03090	GR03590
100	GR030100	GR035100
120	GR030120	GR035120
140	GR030140	GR035140
160	GR030160	GR035160
180	GR030180	GR035180
200	GR030200	GR035200
220	GR030220	GR035220
240	GR030240	GR035240
260	GR030260	GR035260
1050	GR0301050	GR0351050



CUTTER HEAD FOR PROFILE KNIVES



- For serrated 8 mm knives.



TECHNICAL DATA

LENGHT	D122 Z2	D122 Z4	D137 Z2	D137 Z4
20	GC112202002	GC112202004	GC113702002	GC113702004
30	GC112203002	GC112203004	GC113703002	GC113703004
40	GC112204002	GC112204004	GC113704002	GC113704004
50	GC112205002	GC112205004	GC113705002	GC113705004
60	GC112206002	GC112206004	GC113706002	GC113706004
80	GC112208002	GC112208004	GC113708002	GC113708004
100	GC112210002	GC112210004	GC113710002	GC113710004
125	GC112212502	GC112212504	GC113712502	GC113712504
150	GC112215002	GC112215004	GC113715002	GC113715004
180	GC112218002	GC112218004	GC113718002	GC113718004
200	GC112220002	GC112220004	GC113720002	GC113720004
230	GC112223002	GC112223004	GC113723002	GC113723004
250	GC112225002	GC112225004	GC113725002	GC113725004

LENGHT	D157 Z4	D157 Z6	D177 Z4	D177 Z6
20	GC115702004	GC115702006	GC117702004	GC117702006
30	GC115703004	GC115703006	GC117703004	GC117703006
40	GC115704004	GC115704006	GC117704004	GC117704006
50	GC115705004	GC115705006	GC117705004	GC117705006
60	GC115706004	GC115706006	GC117706004	GC117706006
80	GC115708004	GC115708006	GC117708004	GC117708006
100	GC115710004	GC115710006	GC117710004	GC117710006
125	GC115712504	GC115712506	GC117712504	GC117712506
150	GC115715004	GC115715006	GC117715004	GC117715006
180	GC115718004	GC115718006	GC117718004	GC117718006
200	GC115720004	GC115720006	GC117720004	GC117720006
230	GC115723004	GC115723006	GC117723004	GC117723006
250	GC115725004	GC115725006	GC117725004	GC117725006

IF YOU CAN'T FIND WHAT YOU'RE LOOKING FOR PLEASE CONTACT: SUPPORT@MICORTOOLING.COM



HYDRO PROFILE CUTTERHEAD



- For 8 mm serrated knives.
- Product manufactured based on customer dimension needs.
- Quick delivery times.
- Available in aluminum and steel.



TECHNICAL DATA

LENGHT	D157 Z4	D157 Z6
60	GE115706004	GE115706006
80	GE115708004	GE115708006
100	GE115710004	GE115710006
125	GE115712504	GE115712506
150	GE115715004	GE115715006
180	GE115718004	GE115718006
200	GE115720004	GE115720006
230	GE115723004	GE115723006
250	GE115725004	GE115725006

LENGHT	D177 Z4	D177 Z6	D177 Z8
60	GE117706004	GE117706006	GE117706008
80	GE117708004	GE117708006	GE117708008
100	GE117710004	GE117710006	GE117710008
125	GE117712504	GE117712506	GE117712508
150	GE117715004	GE117715006	GE117715008
180	GE117718004	GE117718006	GE117718008
200	GE117720004	GE117720006	GE117720008
230	GE117723004	GE117723006	GE117723008
250	GE117725004	GE117725006	GE117725008

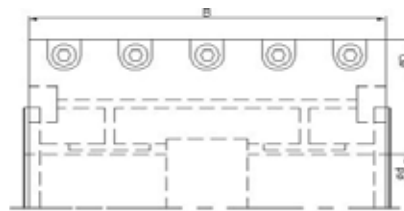



SERRATED PROFILE KNIVES



- HSS 8 mm.



TECHNICAL DATA

LENGHT	H=50, M3	H=60, M3	H=70, M3
20	JE550020M3	JE560020M3	JE570020M3
30	JE550030M3	JE560030M3	JE570030M3
40	JE550040M3	JE560040M3	JE570040M3
50	JE550050M3	JE560050M3	JE570050M3
60	JE550060M3	JE560060M3	JE570060M3
80	JE550080M3	JE560080M3	JE570080M3
100	JE550100M3	JE560100M3	JE570100M3
125	JE550125M3	JE560125M3	JE570125M3
150	JE550150M3	JE560150M3	JE570150M3
180	JE550180M3	JE560180M3	JE570180M3
200	JE550200M3	JE560200M3	JE570200M3

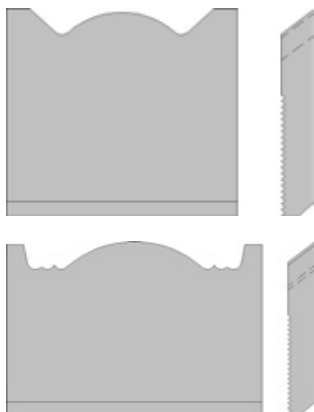



HELICAL PLANING HEAD FOR GOOD FINISH

- Aluminum body with HW-knives.
- Special hydro head can be maximum diameter. 350 mm 4-16 helices and length 308.



TECHNICAL DATA

CUTTER WITH WEINING HSK

DIAM.	LENGHT	HSK	Z / KNIVES (4 HELICES)
125	82	HSK	2+2 / 14
125	104	HSK	2+2 / 18
125	126	HSK	2+2 / 22
125	137	HSK	2+2 / 24

BORE d 30-60 MM

DIAM.	LENGHT	BORE 30-60	Z / KNIVES (4 HELICES)
125	82	30-60	2+2 / 14
125	104	30-60	2+2 / 18
125	126	30-60	2+2 / 22
125	137	30-60	2+2 / 24
125	148	30-60	2+2 / 26
125	170	30-60	2+2 / 30
125	180	30-60	2+2 / 32
125	203	30-60	2+2 / 36
125	225	30-60	2+2 / 36
125	236	30-60	2+2 / 36
160	82	30-60	4+4 / 28
160	126	30-60	4+4 / 44
160	181	30-60	4+4 / 64
160	203	30-60	4+4 / 72
160	236	30-60	4+4 / 84

CUTTER WITH HYDRO d 30-60 MM

DIAM.	LENGHT	BORE 30-60	Z / KNIVES (8 HELICES)	Z / KNIVES (10 HELICES)
160	82	30-60	4+4 / 28	
160	126	30-60	4+4 / 44	
160	181	30-60	4+4 / 64	
160	203	30-60	4+4 / 72	
160	236	30-60	4+4 / 84	
180	181	30-60	4+4 / 64	
180	203	30-60	4+4 / 72	
180	236	30-60	4+4 / 84	
230	181	30-60		5+5 / 80
230	203	30-60		5+5 / 90
230	236	30-60		5+5 / 105



PANELLING CUTTER SET



- New safer tip-pocket design.
- Tongue and groove cutter set.
- New gullet design - longer running time.

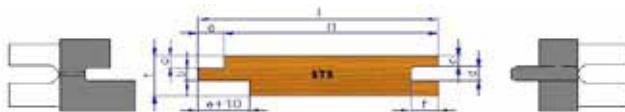

PANELLING CUTTER SET STS

D140 Z4	D160 Z4	D180 Z4	D180 Z6	D200 Z4	D200 Z6	D200 Z8
FC514004	FC516004	FC518004	FC518006	FC520004	FC520006	FC520008
D220 Z4	D220 Z6	D220 Z8	D220 Z10	D220 Z12	D250 Z12	D250 Z16
FC522004	FC522006	FC522008	FC522010	FC522012	FC525012	FC525016

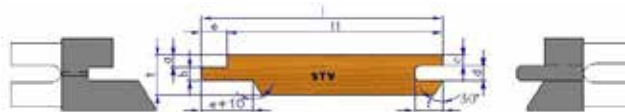

PANELLING CUTTER SET STV

D140 Z4	D160 Z4	D180 Z4	D180 Z6	D200 Z4	D200 Z6	D200 Z8
FD514004	FD516004	FD518004	FD518006	FD520004	FD520006	FD520008
D220 Z4	D220 Z6	D220 Z8	D220 Z10	D220 Z12	D250 Z12	D250 Z16
FD522004	FD522006	FD522008	FD522010	FD522012	FD525012	FD525016

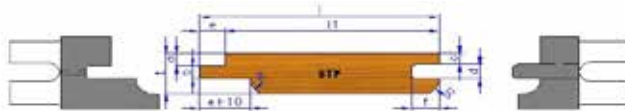

PANELLING CUTTER SET STP

D140 Z4	D160 Z4	D180 Z4	D180 Z6	D200 Z4	D200 Z6	D200 Z8
FR514004	FR516004	FR518004	FR518006	FR520004	FR520006	FR520008
D220 Z4	D220 Z6	D220 Z8	D220 Z10	D220 Z12	D250 Z12	D250 Z16
FR522004	FR522006	FR522008	FR522010	FR522012	FR525012	FR525016

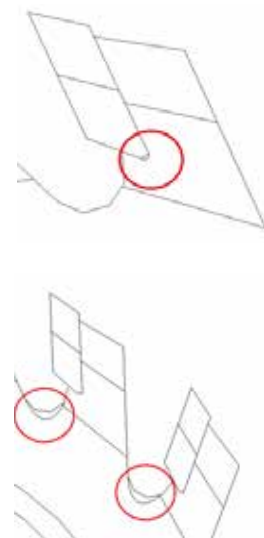

IF YOU CAN'T FIND WHAT YOU'RE LOOKING FOR PLEASE CONTACT: SUPPORT@MICORTOOLING.COM



PANELLING & FLOORING CUTTER SET



- New safer tip-pocket design.
- Tongue and groove cutter set.
- New gullet design - longer running time.



FLOOR PANELLING CUTTER SET HLL

D140 Z4	D160 Z4	D180 Z4	D180 Z6	D200 Z4	D200 Z6	D200 Z8
FE514004	FE516004	FE518004	FE518006	FE520004	FE520006	FE520008
D220 Z4	D220 Z6	D220 Z8	D220 Z10	D220 Z12	D250 Z12	D250 Z16
FE522004	FE522006	FE522008	FE5220010	FE5220012	FE5250012	FE5250016



FLOOR PANELLING CUTTER SET HPL

D140 Z4	D160 Z4	D180 Z4	D180 Z6	D200 Z4	D200 Z6	D200 Z8
FF514004	FF516004	FF518004	FF518006	FF520004	FF520006	FF520008

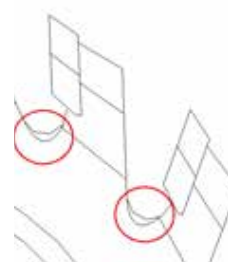
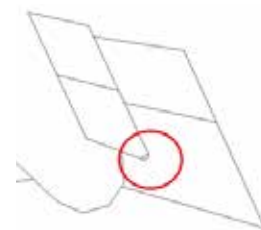



PANELLING & FLOORING CUTTER SET



- New safer tip-pocket design.
- Tongue and groove cutter set.
- New gullet design - longer running time.

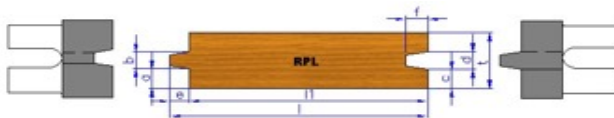

FLOOR PANELLING CUTTER SET RPL

D140 Z4	D160 Z4	D180 Z4	D180 Z6	D200 Z4	D200 Z6	D200 Z8
FJ514004	FJ516004	FJ518004	FJ518006	FJ520004	FJ520006	FJ520008
D220 Z4	D220 Z6	D220 Z8	D220 Z10	D220 Z12	D250 Z12	D250 Z16
FJ522004	FJ522006	FJ522008	FJ5220010	FJ5220012	FJ5250012	FJ5250016

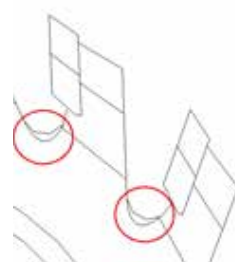



PANELLING CUTTER SET



- Tongue and groove cutter set.
- New safer tip-pocket design.
- New gullet design - longer running time.



PANELLING CUTTER SET UTS

D140 Z4	D160 Z4	D180 Z4	D180 Z6	D200 Z4	D200 Z6	D200 Z8
FA514004	FA516004	FA518004	FA518006	FA520004	FA520006	FA520008
D220 Z4	D220 Z6	D220 Z8	D220 Z10	D220 Z12	D250 Z12	D250 Z16
FA522004	FA522006	FA522008	FA522010	FA522012	FA525012	FA525016

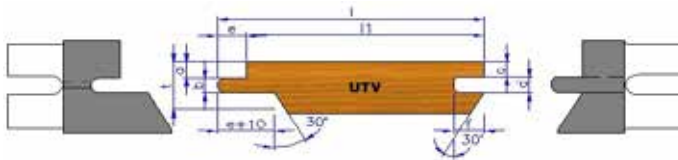

PANELLING CUTTER SET UTV

D140 Z4	D160 Z4	D180 Z4	D180 Z6	D200 Z4	D200 Z6	D200 Z8
FB514004	FB516004	FB518004	FB518006	FB520004	FB520006	FB520008
D220 Z4	D220 Z6	D220 Z8	D220 Z10	D220 Z12	D250 Z12	D250 Z16
FB522004	FB522006	FB522008	FB522010	FB522012	FB525012	FB525016

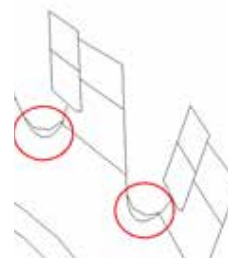
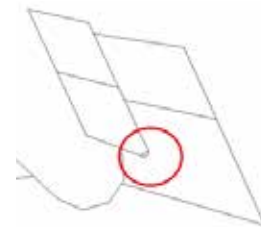



PANELLING CUTTER SET



- Tongue and groove cutter set.
- New safer tip-pocket design.
- New gullet design - longer running time.

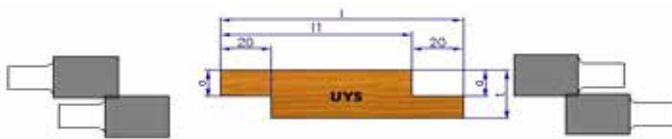

PANELLING CUTTER SET UYS

D140 Z4	D160 Z4	D180 Z4	D180 Z6	D200 Z4	D200 Z6	D200 Z8
FG514004	FG516004	FG518004	FG518006	FG520004	FG520006	FG520008
D220 Z4	D220 Z6	D220 Z8	D220 Z10	D220 Z12	D250 Z12	D250 Z16
FG522004	FG522006	FG522008	FG522010	FG522012	FG525012	FG525016

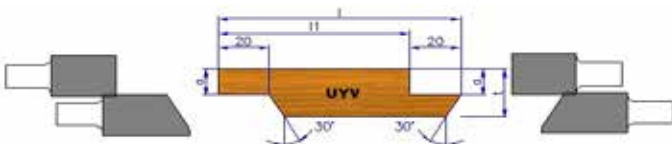

PANELLING CUTTER SET UYV

D140 Z4	D160 Z4	D180 Z4	D180 Z6	D200 Z4	D200 Z6	D200 Z8
FS514004	FS516004	FS518004	FS518006	FS520004	FS520006	FS520008
D220 Z4	D220 Z6	D220 Z8	D220 Z10	D220 Z12	D250 Z12	D250 Z16
FS522004	FS522006	FS522008	FS522010	FS522012	FS525012	FS525016

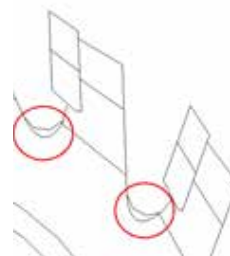



PANELLING PROFILE CUTTER



- Bevelling and rounding profile cutter.
- New gullet design - longer running time.



PANELLING CUTTER STV, UTV, UYV

D180- D200 Z6	D200- D220 Z8	D200- D220 Z10	D220- D250 Z12	D220- D250 Z16
---------------------	---------------------	----------------------	----------------------	----------------------

FDN522006 | FDN522008 | FDN522010 | FDN525012 | FDN525016

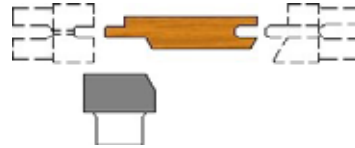

PANELLING CUTTER STP

D180- D200 Z6	D200- D220 Z8	D200- D220 Z10	D220- D250 Z12	D220- D250 Z16
---------------------	---------------------	----------------------	----------------------	----------------------

FRN522006 | FRN522008 | FRN522010 | FRN525012 | FRN525016

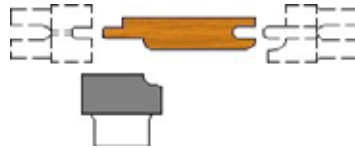

PANELLING CUTTER STS, UYS, UTS

D180- D200 Z6	D200- D220 Z8	D200- D220 Z10	D220- D250 Z12	D220- D250 Z16
---------------------	---------------------	----------------------	----------------------	----------------------

FCN522006 | FCN522008 | FCN522010 | FCN525012 | FCN525016

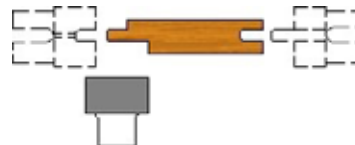

PANELLING CUTTER STK

D180- D200 Z6	D200- D220 Z8	D200- D220 Z10	D220- D250 Z12	D220- D250 Z16
---------------------	---------------------	----------------------	----------------------	----------------------

FBN522006 | FBN522008 | FBN522010 | FBN525012 | FBN525016

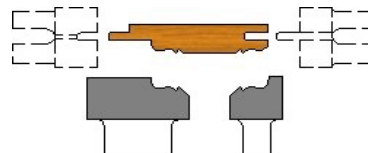



PANELLING PROFILE CUTTER HL



- Bevelling and rounding profile cutter.
- New gullet design - longer running time.

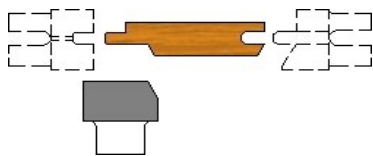

PANELLING CUTTER SET STV, UTV, UYV

D180-D200 Z6	D200-D220 Z8	D200-D220 Z10	D220-D250 Z12	D230-D250 Z14	D230-D250 Z14
MAS522006	MAS522008	MAS522010	MAS525012	MAS525014	MAS525016

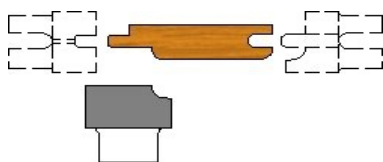

PANELLING CUTTER SET STP

D180-D200 Z6	D200-D220 Z8	D200-D220 Z10	D220-D250 Z12	D230-D250 Z14	D230-D250 Z14
MAP522006	MAP522008	MAP522010	MAP525012	MAP525014	MAP525016

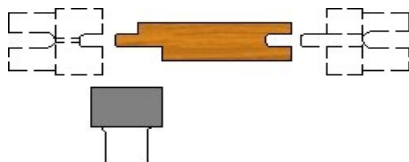

PANELLING CUTTER SET STS, UYS, UTS

D180-D200 Z6	D200-D220 Z8	D200-D220 Z10	D220-D250 Z12	D230-D250 Z14	D230-D250 Z14
MA522006	MA522008	MA522010	MA525012	MA525014	MA525016

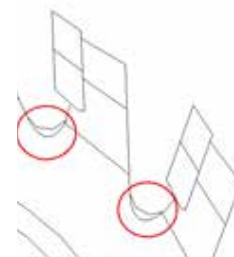

IF YOU CAN'T FIND WHAT YOU'RE LOOKING FOR PLEASE CONTACT: SUPPORT@MICORTOOLING.COM



LOG PANEL PROFILE CUTTER SET

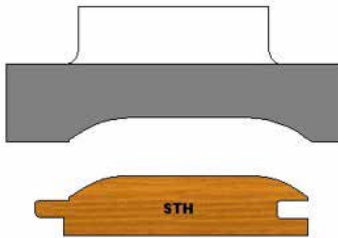

LOG PANEL CUTTER DIMENSIONS AND PROFILING ACCORDING TO CUSTOMERS NEEDS

D120 Z2	D120 Z4	D140 Z2	D140 Z4	D160 Z4	D160 Z6	D180 Z4	D180 Z6	D200 Z4	D200 Z6	D200 Z8
FT512002	FT512004	FT514002	FT514004	FT516004	FT516006	FT518004	FT518006	FT520004	FT520006	FT520008

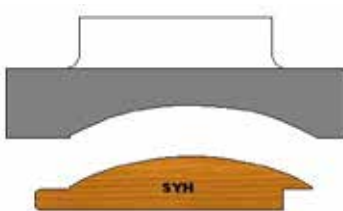

LOG PANEL CUTTER DIMENSIONS AND PROFILING ACCORDING TO CUSTOMERS NEEDS

D120 Z2	D120 Z4	D140 Z2	D140 Z4	D160 Z4	D160 Z6	D180 Z4	D180 Z6	D200 Z4	D200 Z6	D200 Z8
FT512002	FT512004	FT514002	FT514004	FT516004	FT516006	FT518004	FT518006	FT520004	FT520006	FT520008



STRAIGHT CUTTER

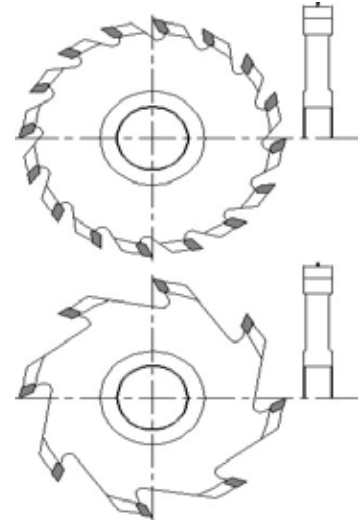

ADJUSTABLE GROOVING CUTTER

- HS (HSS) / HW (HM).
- HS = CH. HW = CG.

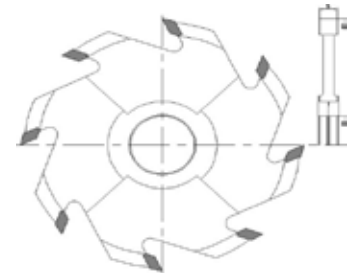

ADJUSTABLE MM B	D200	D220	D240	D260
14-27	CH520014	CH522014	CH524014	CH526014
14-27	CG020014	CG022014	CG024014	CG026014
16-31	CH520016	CH522016	CH524016	CH526016
16-31	CG020016	CG022016	CG024016	CG026016
18-35	CH520018	CH522018	CH524018	CH526018
18-35	CG020018	CG022018	CG024018	CG026018
20-39	CH520020	CH522020	CH524020	CH526020
20-39	CG020020	CG022020	CG024020	CG026020
24-47	CH520024	CH522024	CH524024	CH526024
24-47	CG020024	CG022024	CG024024	CG026024
28-55	CH520028	CH522028	CH524028	CH526028
28-55	CG020028	CG022028	CG024028	CG026028
32-63	CH520032	CH522032	CH524032	CH526032
32-63	CG020032	CG022032	CG024032	CG026032

ADJUSTABLE MM B	D280	D300	D325
14-27	CH528014	CH530014	CH532514
14-27	CG028014	CG030014	CG032514
16-31	CH528016	CH530016	CH532516
16-31	CG028016	CG030016	CG032516
18-35	CH528018	CH530018	CH532518
18-35	CG028018	CG030018	CG032518
20-39	CH528020	CH530020	CH532520
20-39	CG028020	CG030020	CG032520
24-47	CH528024	CH530024	CH532524
24-47	CG028024	CG030024	CG032524
28-55	CH528028	CH530028	CH532528
28-55	CG028028	CG030028	CG032528
32-63	CH528032	CH530032	CH532532
32-63	CG028032	CG030032	CG032532

IF YOU CAN'T FIND WHAT YOU'RE LOOKING FOR PLEASE CONTACT: SUPPORT@MICORTOOLING.COM



ADJUSTABLE CUTTER WITH SPURS

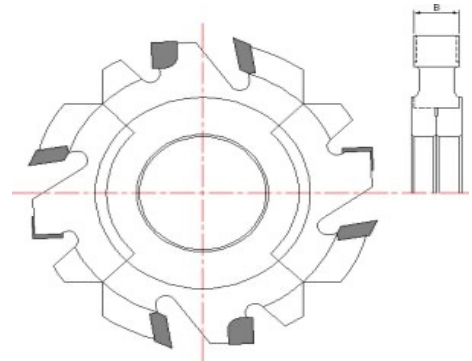

TECHNICAL DATA

ADJUSTABLE CROOVING CUTTER WITH SPURS HW- Z=4+2+2

LENGHTB	D120	D140	D160	D180
4,0 ... 7,5	CA01200408	CA01400408	CA01600408	CA01800408
6,0 ... 11,5	CA01200608	CA01400608	CA01600608	CA01800608
10,0 ... 19,5	CA01201008	CA01401008	CA01601008	CA01801008
18,0 ... 35,5	CA01201808	CA01401808	CA01601808	CA01801808

ADJUSTABLE CROOVING CUTTER WHIT SPURS HS- Z=4+2+2

LENGHTB	D120	D140	D160	D180
4,0 ... 7,5	CB51200408	CB51400408	CB51600408	CB51800408
6,0 ... 11,5	CB51200608	CB51400608	CB51600608	CB51800608
10,0 ... 19,5	CB51201008	CB51401008	CB51601008	CB51801008
18,0 ... 35,5	CB51201808	CB51401808	CB51601808	CB51801808

GROOVING CUTTER WITH SPURS

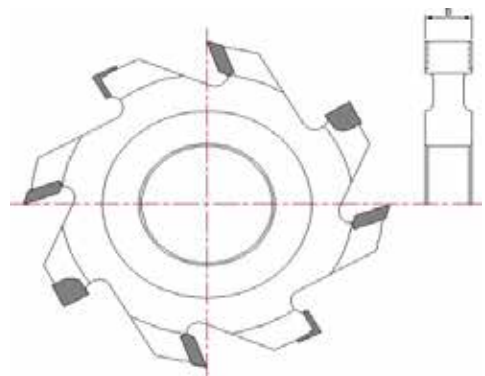

■ HW (HM) / HS (HSS) Z=4+2+2





SPIRAL CUTTER



■ Z=12



TECHNICAL DATA

LENGHT B	D125	D140	D160
80	CI0125080	CI0140080	CI0160080
100	CI0125100	CI0140100	CI0160100
120	CI0125120	CI0140120	CI0160120
150	CI0125150	CI0140150	CI0160150
180	CI0125180	CI0140180	CI0160180
220	CI01252200	CI01402200	CI01602200

HELICAL SPIRAL CUTTER



■ Z=6



TECHNICAL DATA

LENGHT B	D120	D125	D140	D150
54	CI0120054	CI0125054	CI0140054	CI0150054
86	CI0120086	CI0125086	CI0140086	CI0150086
121	CI0120121	CI0125121	CI0140121	CI0150121
135	CI0120135	CI0125135	CI0140135	CI0150135
149	CI0120149	CI0125149	CI0140149	CI0150149
163	CI0120163	CI0125163	CI0140163	CI0150163
177	CI0120177	CI0125177	CI0140177	CI0150177
220	CI0120220	CI0125220	CI0140220	CI0150220



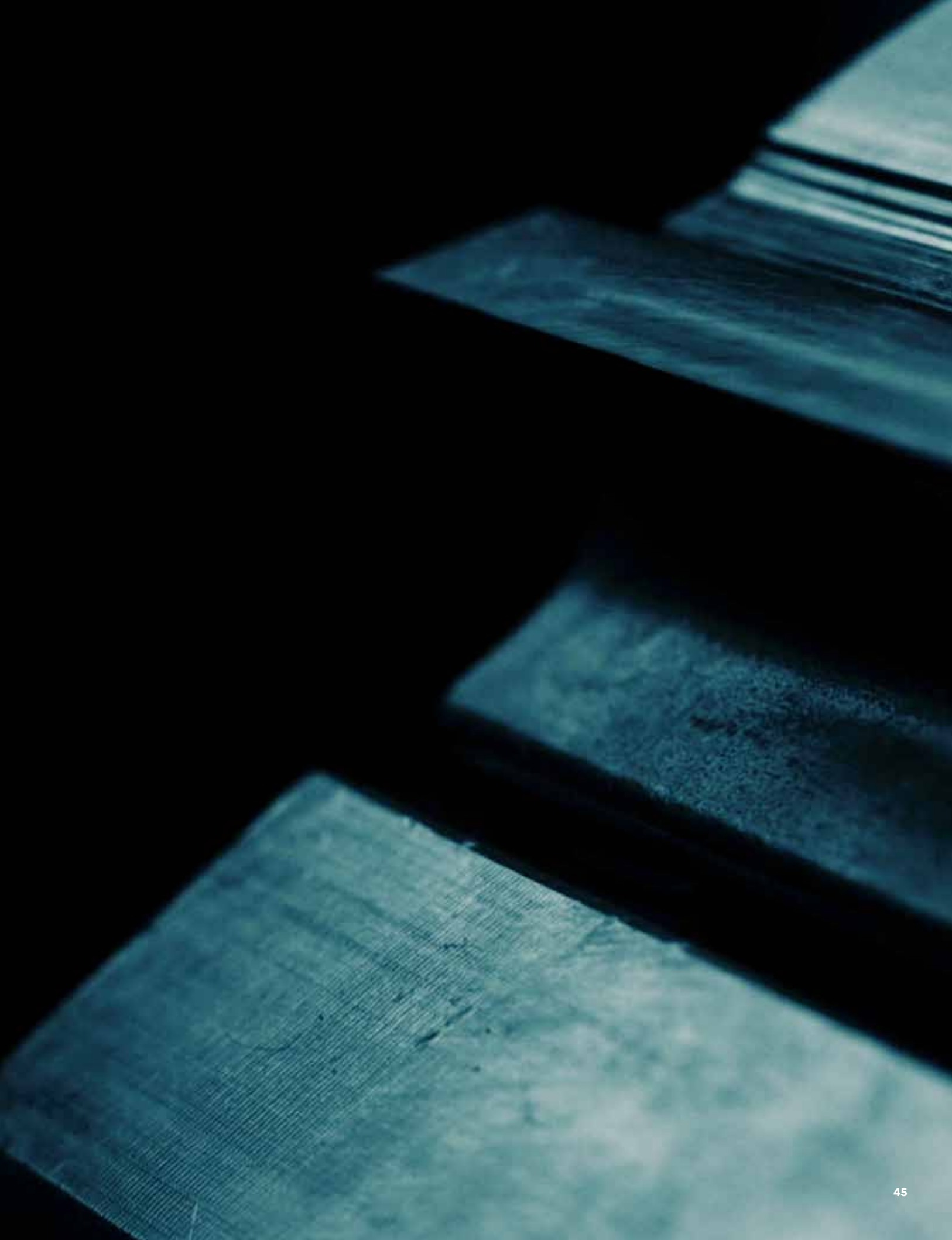



PROFILE GROUPS

- Dimensions and profiling according to customers needs.
- Max diameter = 400 mm.



PROFILE GROUPS 1

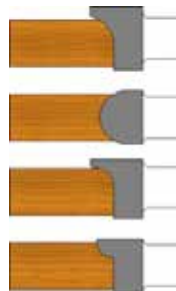

PROFILE GROUPS 2

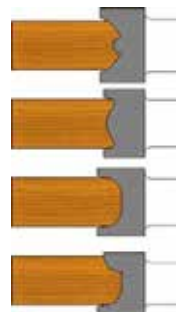

PROFILE GROUPS 3

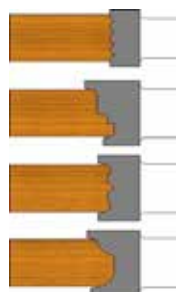



ADJUSTABLE CUTTER



- HW/HS Adjustable mm 15-50 1 set= 2 cutter
- Dimensions and profiling according to customers needs.
- Max diameter = 400 mm.



HW (HM)

Z	D120	D140	D160	D180
4	FL012004	FL014004	FL016004	FL018004
6	-	-	FL016006	FL018006
8	-	-	FL016008	FL018008

Z	D200	D220	D230	D250
10	FL020010	FL022010	FL023010	FL025010
12	FL020012	FL022012	FL023012	FL025012
16	FL020016	FL022016	FL023016	FL025016

HS (HSS)

Z	D120	D140	D160	D180
4	FK512004	FK514004	FK516004	FK518004
6	-	-	FK516006	FK518006
8	-	-	FK516008	FK518008

Z	D200	D220	D230	D250
10	FK520010	FK522010	FK523010	FK525010
12	FK520012	FK522012	FK523012	FK525012
16	FK520016	FK522016	FK523016	FK525016

IF YOU CAN'T FIND WHAT YOU'RE LOOKING FOR PLEASE CONTACT: SUPPORT@MICORTOOLING.COM



WINDOW PROFILE CUTTER

- Dimensions and profiling according to customers needs.



WINDOW PROFILE EXAMPLE

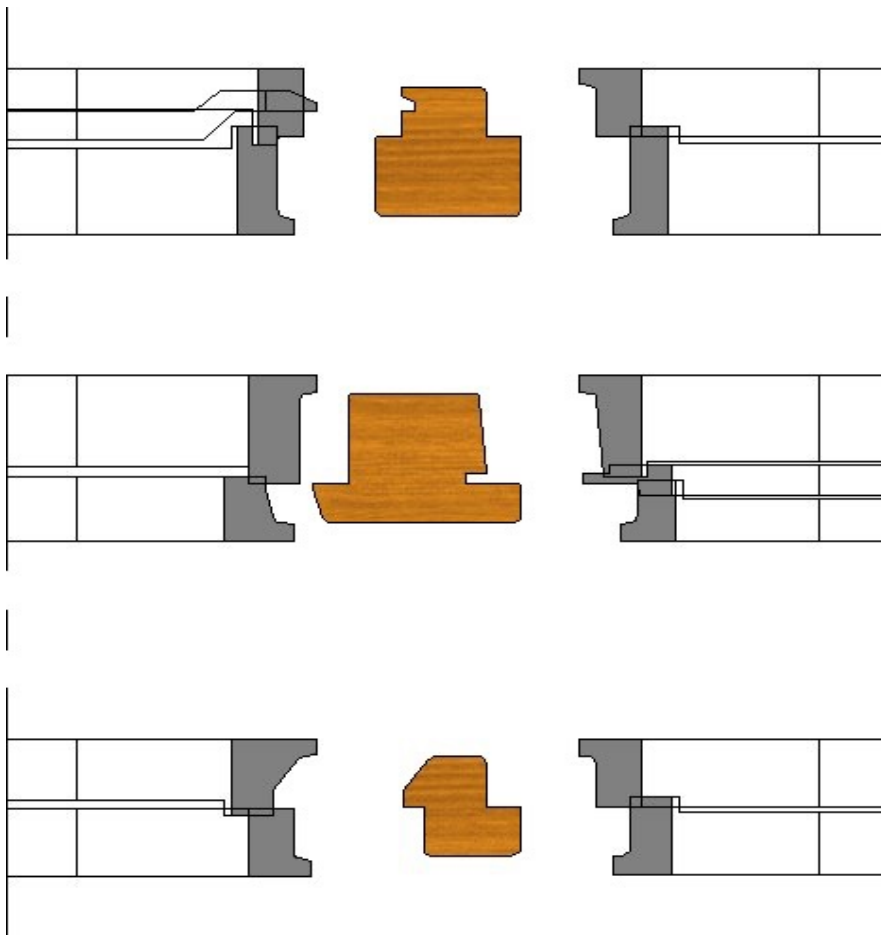



FINGER JOINT CUTTER



FINGER JOINT CUTTER HS (HSS)

D	D160	D220	D170	D220	D180	D220
SL	10	10	15	15	20	20
B	28	28	28	28	33	33
Z	4	6	4	6	4	6

	JOINT HEIGHT	TOOLS PC.		JOINT HEIGHT	TOOLS PC.
FINGER LENGTH 10 AND 15 MM	24	1	FINGER LENGTH 20 MM	28	1
	51	2		59	2
	77	3		90	3
	104	4		121	4
	131	5		152	5
	157	6		183	6
	184	7		214	7
	210	8		245	8
	237	9		276	9
	264	10		307	10

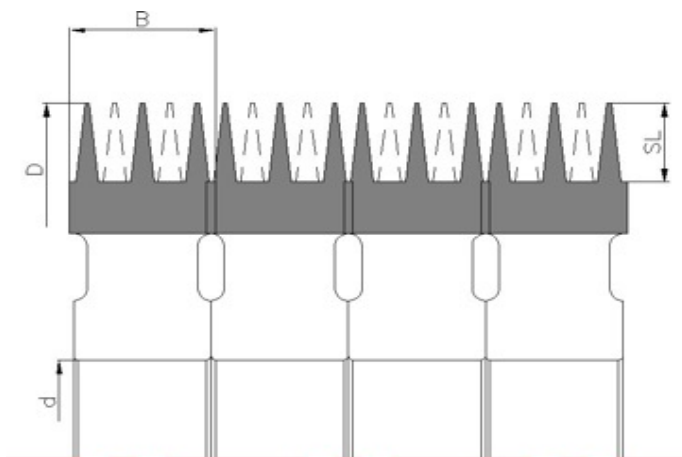



GLUE JOINT CUTTER



HW TOOLS HEIGHT 55 MM. 1 SET = 2 CUTTER

Z	D120	D140	D160	D1800
2	DM012002	DM014002	DM016004	DM018004
4	DM012004	DM014004	DM016006	DM018006

HS TOOLS HEIGHT 55 MM. 1 SET = 2 CUTTER

Z	D120	D140	D160	D1800
2	D0512002	D0514002	D0516004	D0518004
4	D0512004	D0514004	D0516006	D0518006

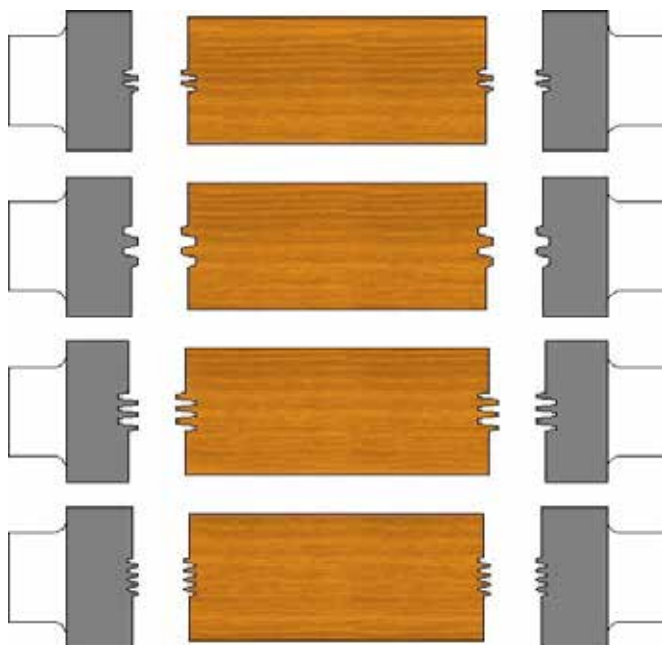



DOWEL CUTTER SET



SINGLE DOWEL CUTTER SET = 2 CUTTERS HS

D140	D140	D160	D180	D180	D200	D200
Z2	Z4	Z4	Z4	Z6	Z6	Z8
F00A14002	F00A14004	F00A16004	F00A18004	F00A18006	F00A20006	F00A20008

MULTIPLE DOWEL CUTTER SET = 2 CUTTER HS

D140	D140	D160	D180	D180	D200	D200
Z2	Z4	Z4	Z4	Z6	Z6	Z8
F00B14002	F00B14004	F00B16004	F00B18004	F00B18006	F00B20006	F00B20008

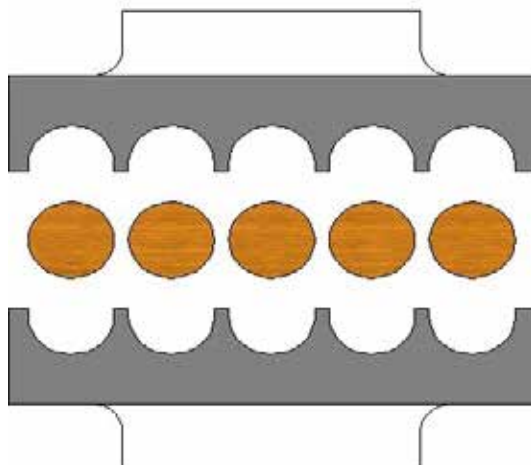

IF YOU CAN'T FIND WHAT YOU'RE LOOKING FOR PLEASE CONTACT: SUPPORT@MICORTOOLING.COM

PROFILE CUTTERS



PROFILE CUTTER SET



- Cutter for covering strips.



SINGLE PROFILE CUTTER SET = 3 CUTTER HS

D140	D140	D160	D180	D180	D200	D200
Z2	Z4	Z4	Z4	Z6	Z6	Z8
FM5A14002	FM5A14004	FM5A16004	FM5A18004	FM5A18006	FM5A20006	FM5A20008

MULTIPLE CUTTER SET = 5 CUTTER HS

D140	D140	D160	D180	D180	D200	D200
Z2	Z4	Z4	Z4	Z6	Z6	Z8
FM5B14002	FM5B14004	FM5B16004	FM5B18004	FM5B18006	FM5B20006	FM5B20008

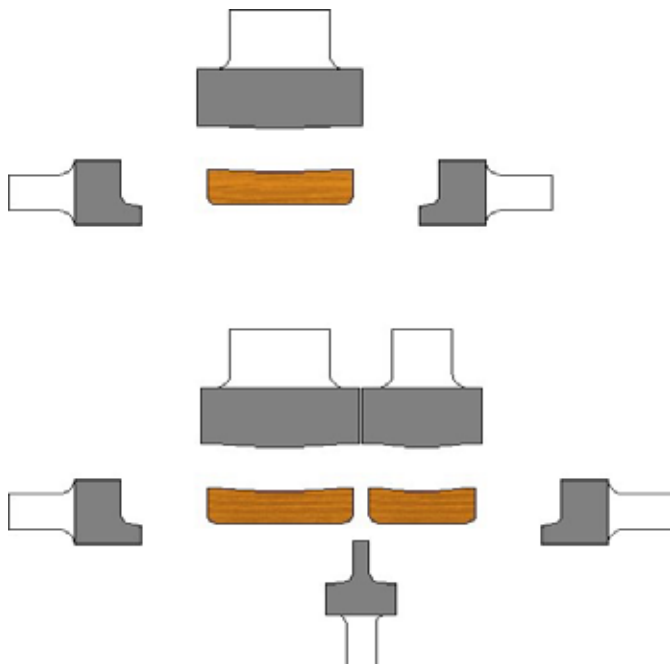

IF YOU CAN'T FIND WHAT YOU'RE LOOKING FOR PLEASE CONTACT: SUPPORT@MICORTOOLING.COM



PROFILE CUTTER SET



- Cutter for floor strips.



SINGLE PROFILE CUTTER SET = 3 CUTTER HS

D140	D140	D160	D180	D180	D200	D200
Z2	Z4	Z4	Z4	Z6	Z6	Z8
FN5A14002	FN5A14004	FN5A16004	FN5A18004	FN5A18006	FN5A20006	FN5A20008

MULTIPLE CUTTER SET = 5 CUTTER HS

D140	D140	D160	D180	D180	D200	D200
Z2	Z4	Z4	Z4	Z6	Z6	Z8
FN5B14002	FN5B14004	FN5B16004	FN5B18004	FN5B18006	FN5B20006	FN5B20008

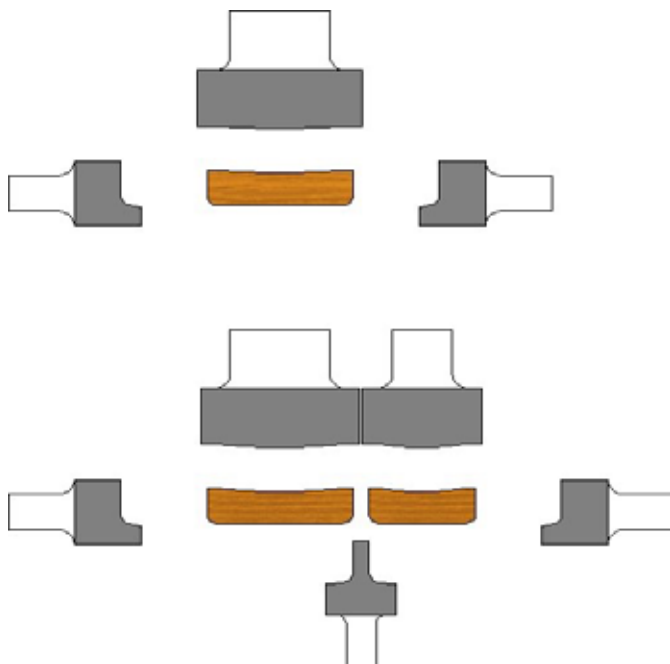

IF YOU CAN'T FIND WHAT YOU'RE LOOKING FOR PLEASE CONTACT: SUPPORT@MICORTOOLING.COM

PROFILE CUTTERS



PROFILE CUTTER SET



- Cutter for glass-securing strips.



SINGLE PROFILE CUTTER SET = 2 CUTTER HS

D140	D140	D160	D180	D180	D200	D200
Z2	Z4	Z4	Z4	Z6	Z6	Z8
FQ5A14002	FQ5A14004	FQ5A16004	FQ5A18004	FQ5A18006	FQ5A20006	FQ5A20008

MULTIPLE PROFILE CUTTER SET = 2 CUTTER HS

D140	D140	D160	D180	D180	D200	D200
Z2	Z4	Z4	Z4	Z6	Z6	Z8
FQ5B14002	FQ5B14004	FQ5B16004	FQ5B18004	FQ5B18006	FQ5B20006	FQ5B20008

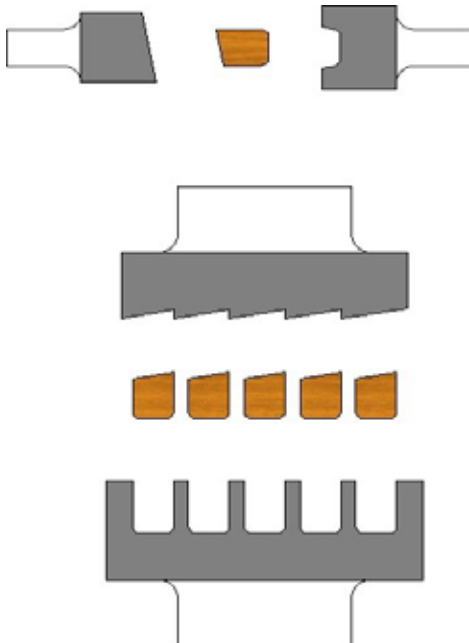

IF YOU CAN'T FIND WHAT YOU'RE LOOKING FOR PLEASE CONTACT: SUPPORT@MICORTOOLING.COM



PROFILE CUTTER SET



- Cutter for window beading.



SINGLE PROFILE CUTTER SET = 2 CUTTER HS

D140	D140	D160	D180	D180	D200	D200
Z2	Z4	Z4	Z4	Z6	Z6	Z8
F05A14002	F05A14004	F05A16004	F05A18004	F05A18006	F05A20006	F05A20008

MULTIPLE PROFILE CUTTER SET = 2 CUTTER HS

D140	D140	D160	D180	D180	D200	D200
Z2	Z4	Z4	Z4	Z6	Z6	Z8
F05B14002	F05B14004	F05B16004	F05B18004	F05B18006	F05B20006	F05B20008

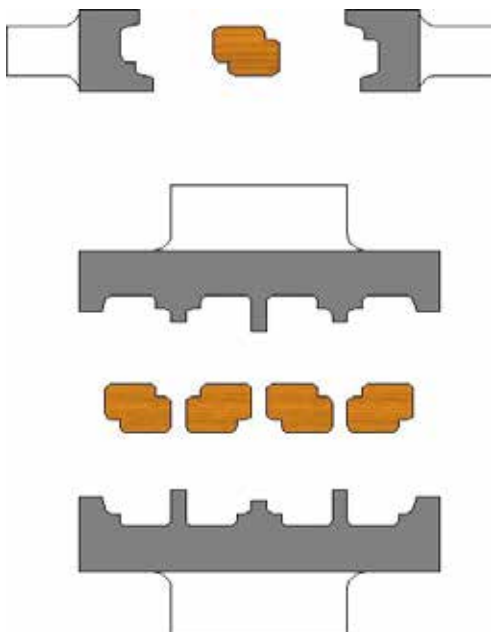

IF YOU CAN'T FIND WHAT YOU'RE LOOKING FOR PLEASE CONTACT: SUPPORT@MICORTOOLING.COM



PLANER CUTTER FOR ROUND & SQUARE LOG



**TOOL DESIGN ACCORDING
TO MACHINE SPECIFICATIONS
AND CUSTOMER DEMAND**

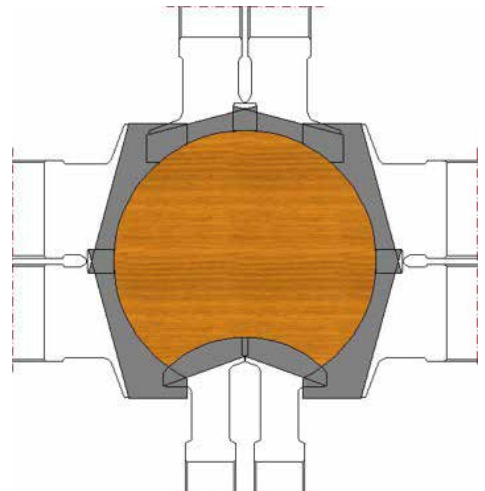
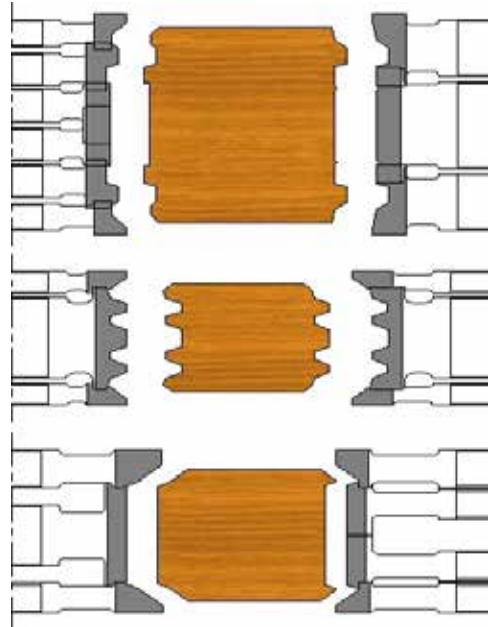



LOG SADDLE CUTTER SET



TOOL DESIGN ACCORDING TO MACHINE SPECIFICATIONS AND CUSTOMER DEMAND



SPECIAL CUTTER FOR LOG CORNER JOINT



- Z=12 + 4 SPRUS



TECHNICAL DATA

DIAMETER	LENGHT	ORDER NO
130	200	HR513020016
150	200	HR515020016
170	220	HR517022016
190	250	HR519025016
210	280	HR521028016
230	280	HR523028016
250	280	HR525028016

SPECIAL DRILL FOR LOG



TECHNICAL DATA

D	LENGHT	ORDER NO
25	240	HH525240
30	270	HH530270
32	280	HH532280
40	300	HH540300



SPLITTING SET

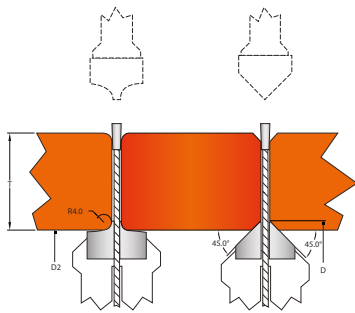



JOINT CUTTERS FOR INSULATION PANELS

- With brazed tips.



STRAIGHT CUTTERS FOR INSULATION PANELS

- With changeable knives.





HOGGER UNITS

- Brazed tool for customized applications.



SEGMENT HOGGER UNITS

- Spiral segments for customized applications.





In Finland, Lahden Teräteos is a manufacturing pioneer of, among others, diamond blades, developed for woodworking applications and requiring demanding specially qualified know-how since 1960. Continuous further development of products and services, together with highly trained and motivated personnel has made LTT as a leading profiled tool manufacturer in Finland. LTT are able to offer the highest grinding quality for PCD diamond tools and offering the best sharpening service.

CONTACT US!

PHONE: +358 3 8733 100. E-MAIL: LTT@LAHDENTERATEOS.FI
WWW.LAHDENTERATEOS.FI



INDUSTRIGATAN 10, SE-312 34 LAHOLM, SWEDEN. PHONE +46 430 492 00.
E-MAIL: SUPPORT@MICORTOOLING.COM. WWW.MICORTOOLING.COM